



Features

Eco-Friendly Refrigerant

R290 refrigerant with a global warming potential (GWP) of 3

High-Strength Door

Heavy-duty, stainless steel door assembled using high-load brackets for long lasting durability

Stainless Steel Exterior

Galvanized back and bottom to reduce the risk of corrosion

Easy to Clean

Aluminum interior, coved corners, finished edges, and removable shelves

Heavy-Duty Soft Casters

Secured to a 12 gauge steel base to ensure years of worry-free operation

High-Efficiency Refrigeration System

Forced air circulation provides uniform temperature throughout the cabinet while automatic defrost self-manages ice buildup and evaporates moisture

Cabinet Capacity

Internal area of 6.3ft³ with two (2) heavy-gauge wire shelves — adjustable in 1/2" increments using stainless steel pilasters

Long-Lasting, Removable Gaskets

Santoprene™ gaskets last four times longer than standard gaskets

High-Density Insulation

Foamed-in-place, CFC-free polyurethane insulation for maximum strength, rigidity, and insulation

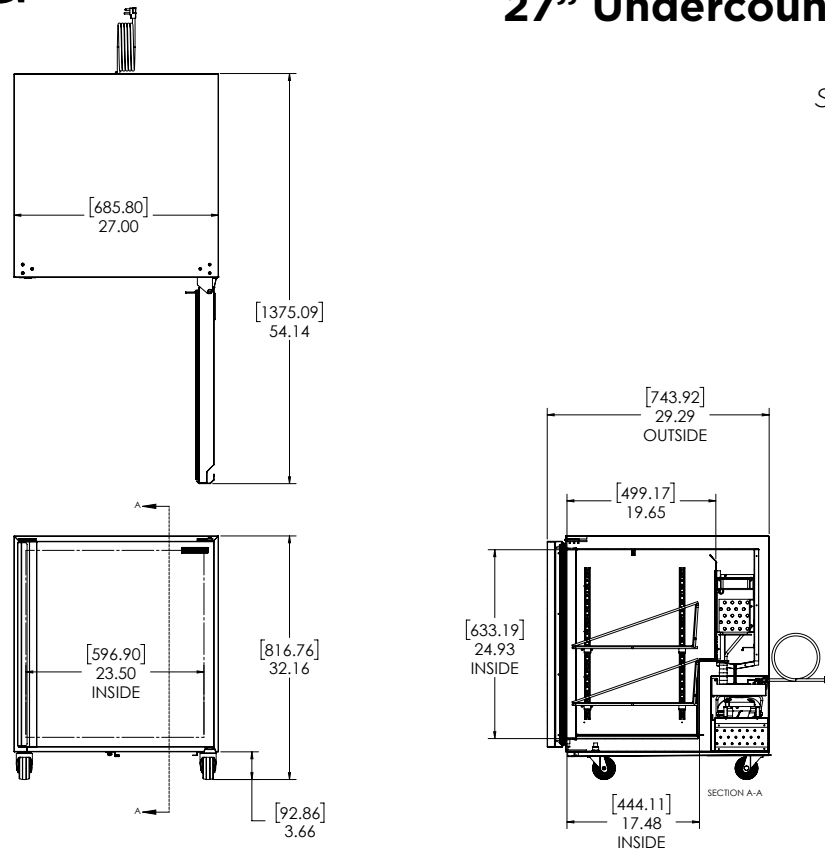

Technical Specifications

Electrical Requirements	115v/60hz/1ph/2A/NEMA 5-15P Plug
Product Dimensions	27"W x 32.15"H x 29.32"D (68.58cm x 81.66cm x 74.47cm)
Product Weight	150lbs (68.04kg)
Shipping Dimensions	32"W x 40"H x 37"D (81.28cm x 101.60cm x 93.98cm)
Shipping Weight	165lbs (74.84kg)
Shipping Cubic Dimensions	27.41ft ³ (0.78m ³)
Temperature Range	-5 to 5 (-20.6 to -15°C)
Refrigerant	R290
Charge Level	4.1oz (116 grams)

Insulation	Foamed-in-place, CFC-free polyurethane
Exterior Construction	Stainless steel exterior with galvanized back and bottom
Interior Construction	Aluminum interior with coved corners and finished edges
Doors	One (1) right-hand swing door
Interior Capacity	6.3ft ³
Door/Drawer Gasket	Santoprene™ gasket
Shelves	Two (2) heavy-gauge wire shelves
Casters	Four (4) 3" heavy-duty soft casters (two locking)
Certifications	ETL Safety, ETL Sanitation
Warranty	1-year parts and labor, 5-year compressor (part only)

Model Number	Description
SKF27A-ESUS1	Undercounter Freezer 27", 115v/60hz/1ph, single right-hand swing door, 3" heavy-duty soft casters (two locking), NEMA 5-15P

To learn more about **Undercounter Freezer**, visit silverking.com